

CP 60

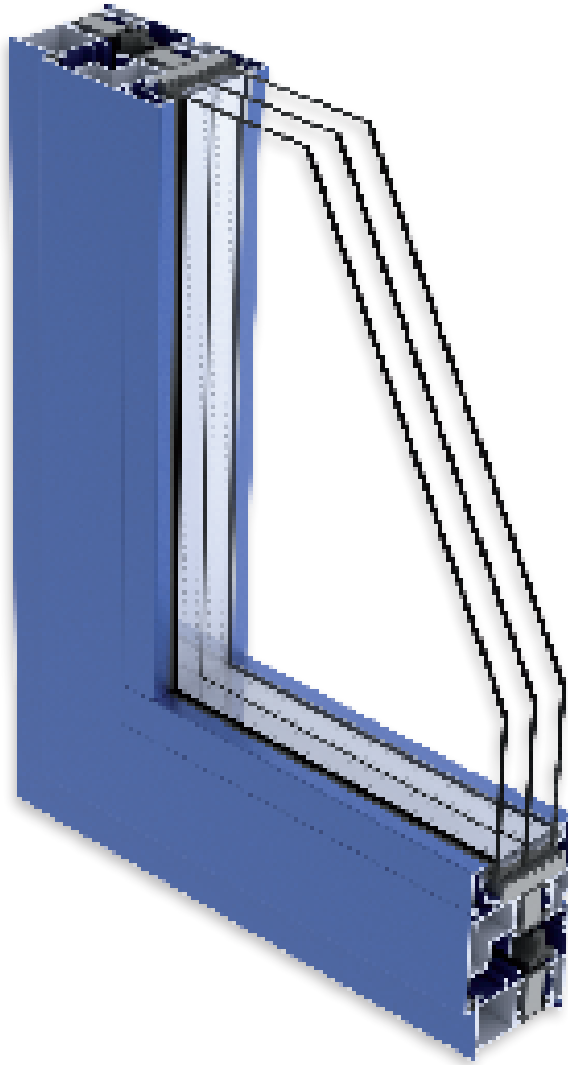

www.vital.es

ÍNDICE

- CARACTERÍSTICAS TÉCNICAS
- DATOS TÉCNICOS PERFILES
- PERFILES
- FÓRMULAS DE CORTE
- ACCESORIOS

CARACTERÍSTICAS TÉCNICAS

SISTEMAS DE CORREDERAS

CP - 60

Corredera PERIMETRAL de dos y tres hojas para la fabricación de ventanas con dos opciones, para cristal monolítico y con doble acristalamiento 20 mm.

Es un cerramiento de estética innovadora y soluciones técnicas especiales para facilitar el trabajo en el taller y la colocación en obra.

Carriles de rueda ancha, y juntas que garantizan la estanqueidad necesaria para dar una alta clasificación en banco de pruebas. (en proceso).

Los acabados superficiales en anodizado y lacado disponen de los sellos de calidad EWAA-EURAS i QUALICOAT, respectivamente.



RESULTADOS:

<i>ESTANQUEIDAD AL AIRE:</i>	<i>Clase 3</i>
<i>ESTANQUEIDAD AL AGUA:</i>	<i>Clase 7 A</i>
<i>RESISTENCIA AL VIENTO:</i>	<i>Clase C 5</i>

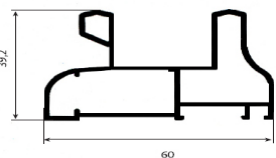
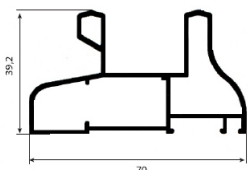
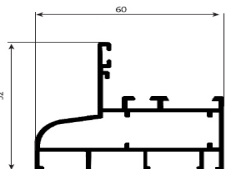
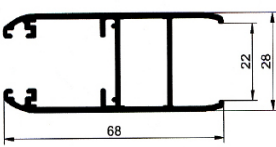
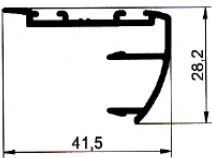
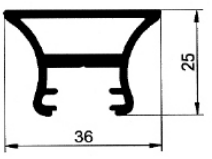
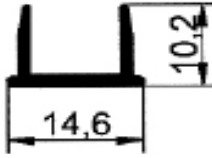
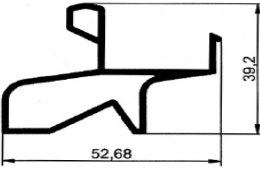
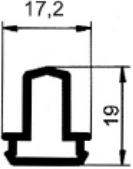
DATOS TÉCNICOS

PLANO	DESCRIPCIÓN	REF	OSERVACIONES
	Marco de 60	15410	
	Marco de 70	15412	
	Marco fijo	15430	
	Hoja	15420	
	Cruce hojas	15421	
	Refuerzo vertical hojas	15432	
	Tapa tornillos refuerzo	15431	
	Tercer carril marco de 70	15435	
	Perfil unión 4 hojas	15445	

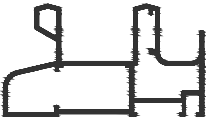
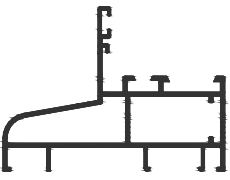
DATOS TÉCNICOS

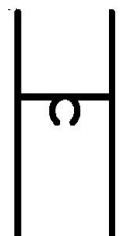
PLANO	DESCRIPCIÓN	REF	OBSERVACIONES
	Marco con recogedor	15413	
	Marco fijo 70	15429	
	Reductor Vidrio	15346	
	Unión Marco 60	15241	
	Travesaño hoja	15325	

PERFILES

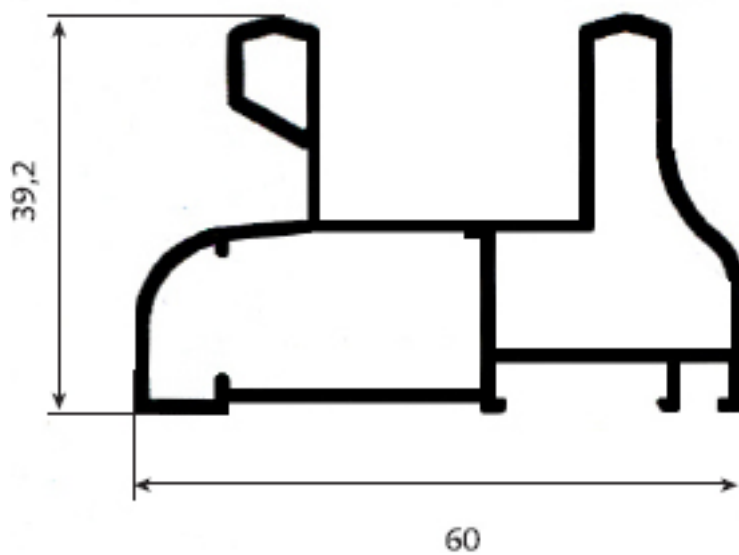

15410
MARCO DE 60

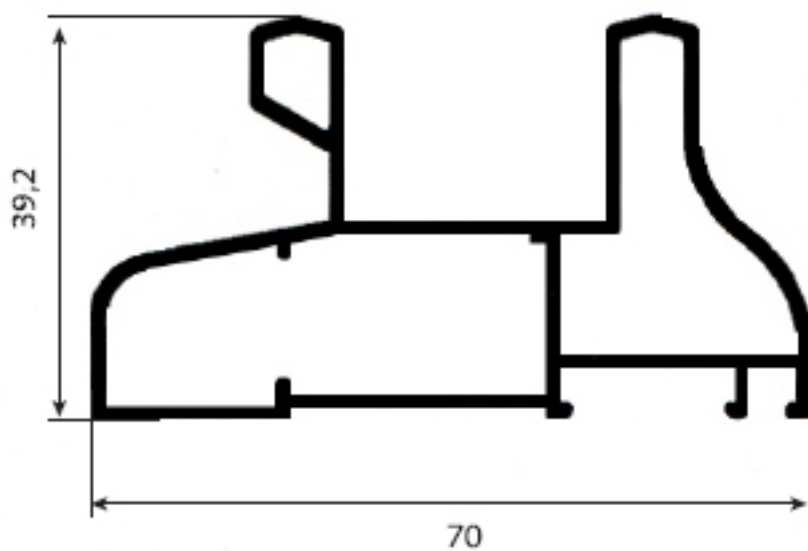

15412
MARCO DE 70

PERFILES

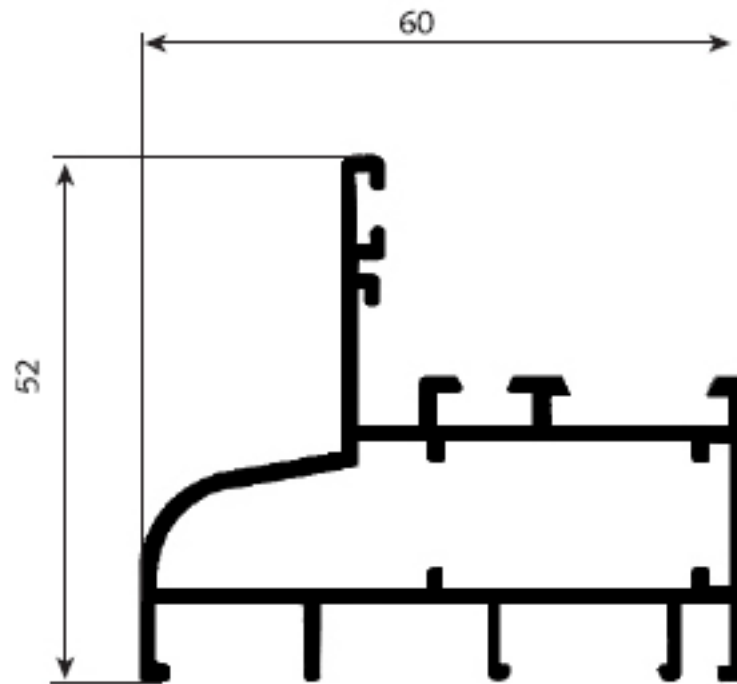

15430
MARCO FIJO

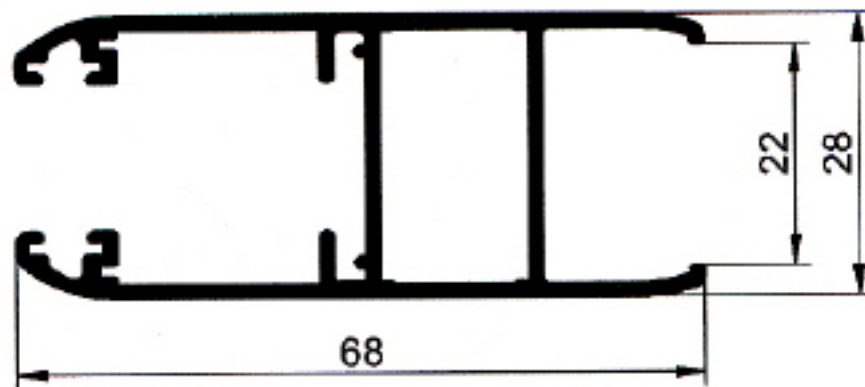

15420
HOJA

PERFILES

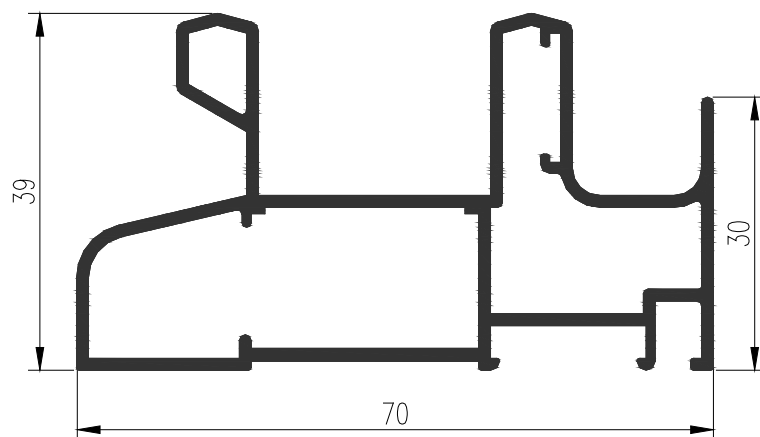

15413

MARCO CON RECOGEDOR

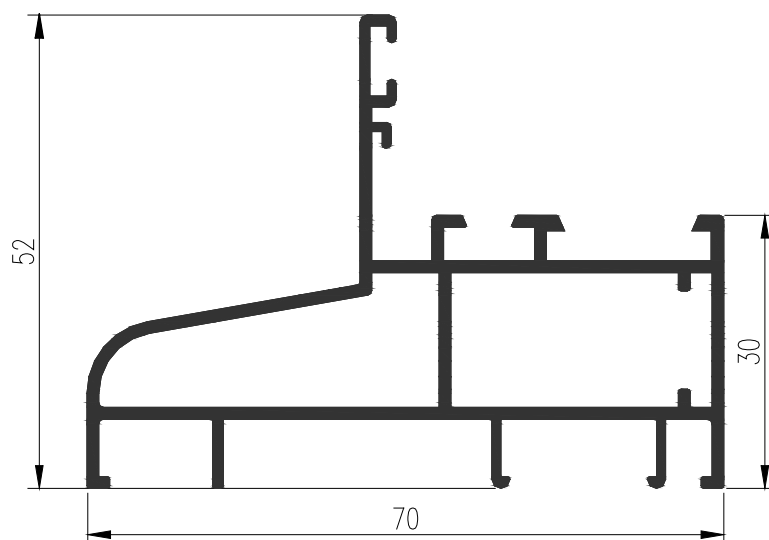

15429

MARCO FIJO 70

PERFILES

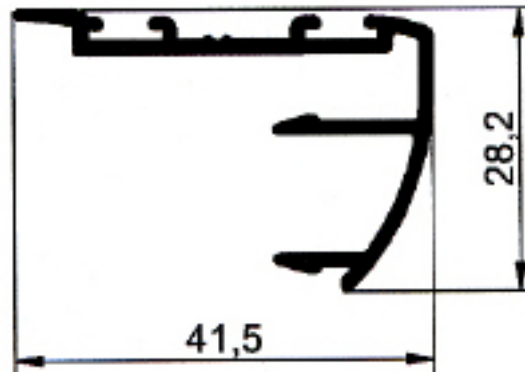

15421
CRUCE HOJAS

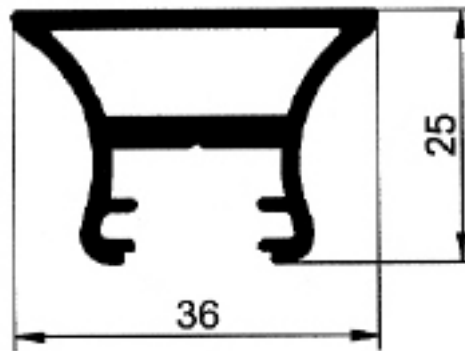

15432
REFUERZO VERTICAL HOJAS

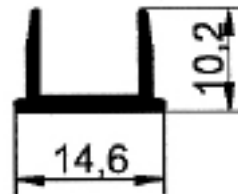

15431
TAPA TORNILLO REFUERZO

PERFILES

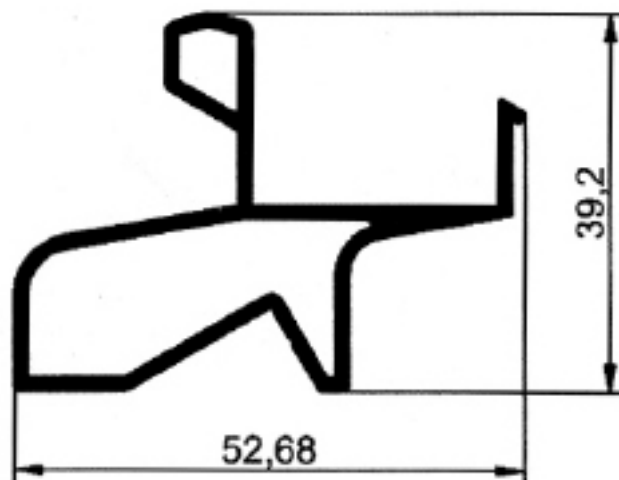

15435

TERCER CARRIL MARCO DE 70

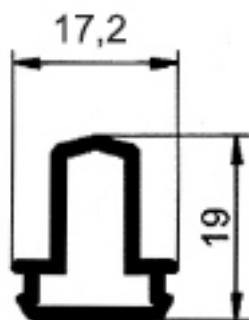

15445

PERFIL UNIÓN 4 HOJAS

PERFILES

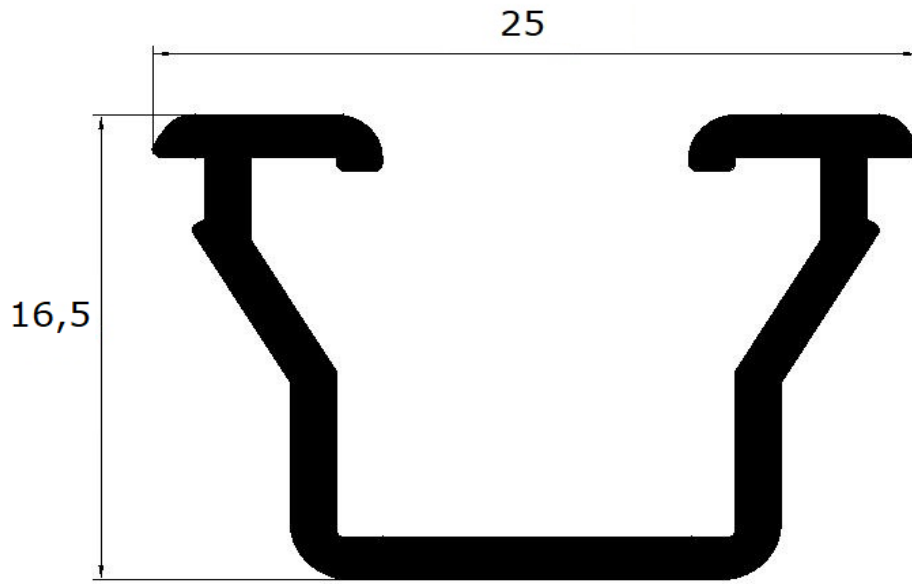

15346
REDUCTOR VIDRIO

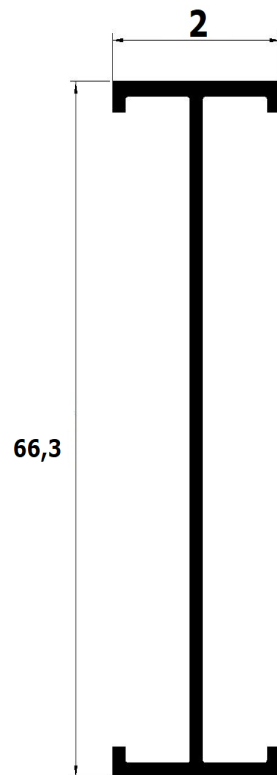

15241
UNIÓN MARCO

PERFILES

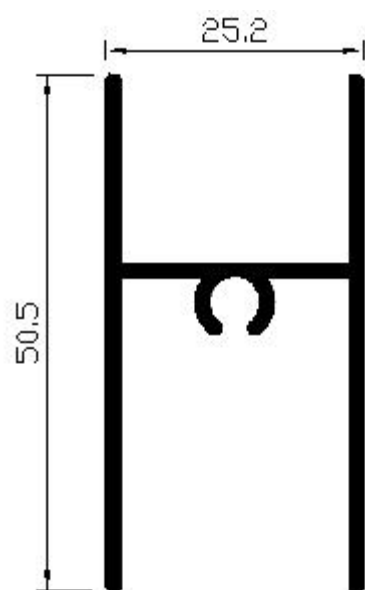

15325
TRAVESAÑO HOJA

**FÓRMULAS DE CORTE,
ACCESORIOS Y SECCIONES
CP 60 / CP 70**





FÓRMULAS DE CORTE

REFERENCIA	POSICIÓN	UDS.	FÓRMULA DE CORTE
MARCOS	L	2	L
	H	2	H
15420	L	4	$(L - 2)/2$
	H	4	H - 61
15421	H	2	H - 151
CRISTALES	L	2	$(L - 226) / 2$
	H	2	H - 173

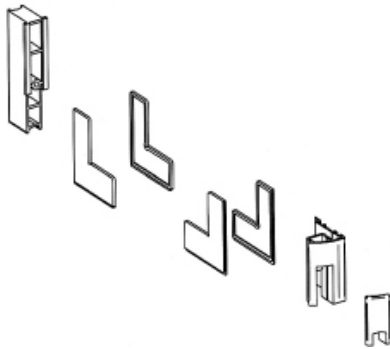

ACCESORIOS

	REFERENCIA	DENOMINACIÓN	OBSERVACIONES
	20221	- Cierre BRIO	
	20224	- Tirador ext BRIO llave	
	20221SE	- Unidad cierre con llave KLEIDI	
	20228	- Ganxo marco perimetral	
	20229	- Ganxo hoja perimetral	
	20225	- Asa para 20221	
	24010	- Escuadra de marco y hoja	
	20188	- Cortavientos superior e inferior	
	20616FR	- Cojinete simple agujas	
	20617FR	- Cojinete tandem agujas	

ACCESORIOS

	REFERENCIA	DENOMINACIÓN	OBSERVACIONES
		- 20190 - Kit para hoja corredera perimetral	
	25106 25108 25107 25110 25109	- Cierre multipunto 270 mm - Cierre multipunto 600 mm (2 puntos) - Cierre multipunto 1.600mm (3 puntos) -Cierre multipunto 1000mm -Cierre multipunto 1800mm	
	25102	- Calce de apoyo cremona	
	25101	-Calce apoyo marco	
	25104	- Seguro anti-elevación	

ACCESORIOS

	REFERENCIA	DENOMINACIÓN	OBSERVACIONES
	25105	-Cerradero marco	
	25115	-Manilla	
	25118	- Uñero multipunto	
	24218	- Manilla Kora	
	25234SE	-Manilla Acodada Dch	
	25235SE	- Manilla Acodada Izq	
	20186	-Tapas perfil 4 hojas	

NOTA:

Consultar con la Oficina Técnica las posibilidades para colocar cerraduras y diferentes sistemas de cierres multipunto.